



AQUBE® LH9

CLEANING TECHNOLOGY

Made in Germany

Fully automatic state of the art PowerSpray® XXL fine cleaning system for mass cleaning of assembled PCBs

Cleans PCBs, hybrids and misprints from flux residues, resin, copper, oxide and soldering support substances

Capacity: up to 830 (19 m²) eurocards in up to two variable drawer baskets

Part number: 0905AQ9LH11 / 0905AQ9LH21 (HT version)

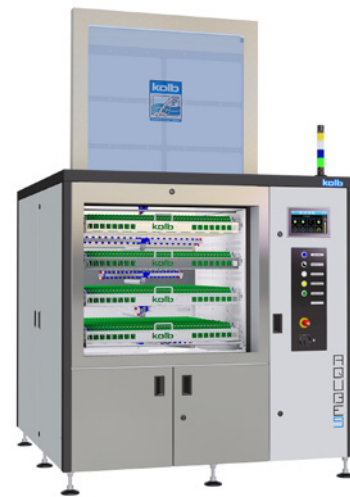

Certifications:

This system in its basic version was certified for its energy and water saving processing, for easy operability and for the standard integration of comprehensive safety features.

- * Two tank system with triple circuit function
- * Intelligent network connectivity for implementation in industry 4.0 smart factories
- * Fully automatic 4step process: cleaning, rinsing (tap water), DI-water rinsing, drying with VMH®-TurboDigital hot air
- * 6.5 seconds relative cycle time for the cleaning, rinsing and drying of one eurocard
- * Suitable for horizontal DCB / power electronics cleaning (with option CWA®-supercharger compression drying)
- * Horizontal PTFE mounted rotor system with up to eight asynchronous spray rotors for thorough wetting (no blind spots)
- * Automatic monitoring of ionic residues contamination and controlling of rinse water quality
- * Process and service intervals PLC controlled, event issuing and software control via touch screen
- * EDGELESS Design and VARAccess® maintenance access: maximum capacity on a very small footprint
- * HT version for high temperature cleaning and rinsing up to 80 °C available

Key applications

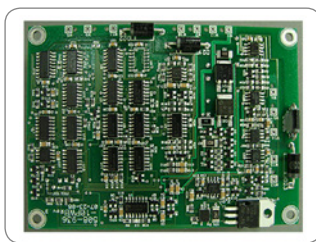

Assembled PCBs

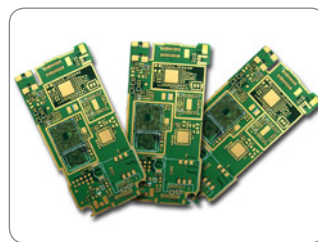

Hybrids (HDIs)

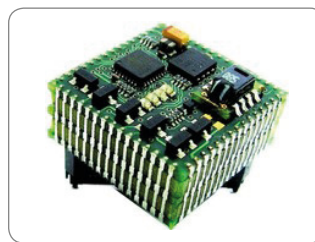

Hybrids (SiPs)

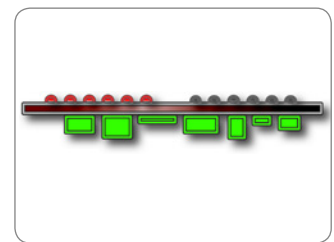

Misprints

The new kolb AQUBE® series offer next-generation cleaning systems - even more efficient, even more compact, easy to handle and maintain, pre-equipped for extended water management and cyber-physically ready for the smart factory (SF ready).

AQUBE® LH9 is a completely German engineered and manufactured fully automatic XXL high volume PCB fine cleaning system with by far the largest process chamber in a PCB cleaning batch system worldwide and thus with higher capacity per time than even any common inline system: (860 / 19m² eurocards in one cleaning cycle, corresponding to a relative cleaning time of 6.5 seconds per card).

The two-tank, three-circuit configuration ensures short cycle times and makes this system the perfect economic choice for the precision mass cleaning of assembled PCBs.

The cleaning system can be operated with all common electronics cleaning supplies (detergents / chemistry, etc.) which are approved by the manufacturer.

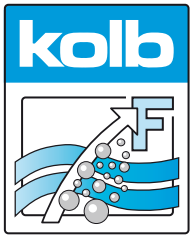





AQUBE® LH9

Fully automatic state of the art PowerSpray® XXL fine cleaning system for mass cleaning of assembled PCBs

Part number: 0905AQ9LH11 / 0905AQ9LH21 (HT version)



Application overview

 Most suitable	 Optional suitable	 Optional suitable	 Optional suitable	 Not suitable
Assembled PCBs Hybrids Misprints	Stencils Screens, PumpPrints Misprints	Solder frames Solder carriers Solder masks	ESD Boxes Containers Magazines	Condensation traps Filters Steel sheets

Optional suitable applications can also be optimally realized with the appropriate options.

Cleaning (key process 1): From the cleaning tank (A) the cleaner liquid is sucked by a magnetically coupled pump unit and routed with a controllable volume flow through a separate circuit into the PTFE mounted ASYNCHRO® stainless steel spray rotors with patented PUSHFORCE® nozzles. Their geometry ensures a comprehensive and thorough cleaning, even in inaccessible and critical areas. After the washing procedure, the valve switchover of the process chamber undocks the cleaning circuit until the next process run.

MediumWipe® (optional intermediate process): The remaining cleaner is blown off from the clean products and blown out of the cleaner circuit and recirculated into the cleaning tank before the valve switchover closes.

Rinsing with tap water (key process 2): From the rinsing tank (tank B / C), the water is pumped through the separate second circuit into the spray rotors. Tap water has (compared to DI / DM water) the advantage of lower surface tension and thus flushes also critical points as low standoffs more efficient.

MediumWipe® (optional intermediate process): The remaining water is blown off from the products and blown out of the cleaner circuit and recirculated into the rinsing tank.

Clear rinsing with DI / DM water (key process 3): The DI / DM water is produced from tap water in an integrated MB-cartridge and flushes conducting ions of the previous processes. This process is repeated automatically until the remaining amount of ions falls below the programmed value.

MediumWipe® (optional intermediate process): Blowing off and recirculating the remaining DI / DM water into the rinsing tank.

Drying (key process 4): The clean products are dried with the patented VMH® (Venturi Mixed Hot air) technology. A high volume flow of normal circulating air is blown into a venturi nozzle. The resulting differential pressure there (passively) sucks on a small amount of very high temperature air. The resulting air mixture provides for uniformly high drying temperature (adjustable between 45 and 120 °C) all over the process chamber. Further advantages are robustness and low cost of ownership. Energy is only needed for a fan and the heating of a very small amount of air; the rest is executed by pressure differences and air duct geometry.

Maintenance: The system has a VARAccess® maintenance access system with recessed, variable doors and removable panels. In the maintenance area among others are the pump-out set, the optional re-dosage unit with space for a 25 liter detergent and a 5 l additive container as well as the MB cartridge for DI / DM water processing. Tank levels as well as pressure values and maintenance cycles are monitored by the PLC and displayed on the touch screen.



AQUBE® LH9

Fully automatic state of the art PowerSpray® XXL fine cleaning system for mass cleaning of assembled PCBs

Part number: 0905AQ9LH11 / 0905AQ9LH21 (HT version)

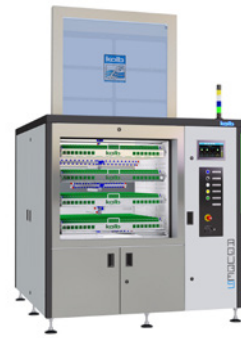

Main standard features

- PowerSpray® technology bundle: magnetically coupled X-power pump unit, twofold ASYNCHRO® volume-spray rotorsystem with low maintenance PTFE mounted stainless steel rotors with PUSHFORCE® nozzles, "Option101" softwareprogram (101 freely selectable programs)
- PolyPower® XL configuration with XL-Power pump unit
- EATON Programmable Logic Controller (PLC) with module extension for special programming and technology extensions
- Smart Factory ready: DNAccess® (standard) for remote control (see options) and traceability with retractable touch monitor and integrated industrial PC (see options)
- High resolution 10" (1.024 x 600 px) display with capacitive multi-touch and intuitive process view
- Electrically driven large double-wall airlock door: transparent or process-related with internal pane made of stainless steel
- Fourfold alternating LED status light bar integrated in the system frame
- Lower VA drawer basket, ESD-safe with grounding connection for the operator
- Full flow coarse filter (process chamber)
- Heater for tank A (cleaning)
- Automatic monitoring of ionic residues contamination and gauging of rinse water quality
- Adjustable DI / DM water mixing and blending unit
- VMH® TurboDigital hot air evaporative drying (control range approx. 45 - 120 °C)
- ClosedLoop reprocessing of cleaning and rinsing fluids
- HMA software and pre-equipping for HMA hardware (Heavy Metal Adsorber) for the cleaning circuit (see options)
- Spare space for MB- / DI-cartridge for deionized (DI) and demineralized (DM) water
- Exchange for rinse water and pump out unit
- Safety features: safety interlock on the process chamber door, overflow alarm for all tank sections, overheating protection for all heating and drying elements, end switches for all motor-driven valves and drives, personnel protection insulation
- VARIccess® service access with right and left-hinged side doors as well as unhinging possibility for side doors, front panel, and rear supply rail
- EDGELESS housing design. Doors, cover panels and hinges without edges, depot for traceability scanner and monitor in the right side panel
- Process sections made of electrolysis resistant elements

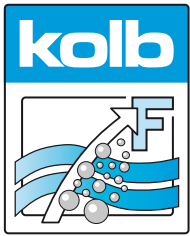

AQUBE® LH9

Fully automatic state of the art PowerSpray® XXL fine cleaning system for mass cleaning of assembled PCBs

Part number: 0905AQ9LH11 / 0905AQ9LH21 (HT version)



Main options

- AOSelection® bundle to separate mandatory disposable and public sewage network dischargeable rinse water
- Automatic re-dosage unit for 25 l detergent and 5 l additive container
- Automatic water change for cleaning circuit (only HT version)
- Cartridge fine filter for cleaning and rinsing circuit
- CWA®-supercharger compression drying (i.a. for DCB cleaning)
- Descaling unit to reduce the lime content in the rinsing water
- Drip & storage reservoir
- Exhaust unit
- Fine filter for cleaning & rinsing circuit
- HMA filter (Heavy Metal Adsorber) unit for the cleaning circuit
- HT Version for high temperature cleaning up to 80 °C
- MB / DI cartridge for deionized (DI) and demineralized (DM) water
- MediumWipe® unit for further optimization of detergent and rinsing fluid use
- Optional lacquering (frame rack and coverings)
- Permanent automatic rotor run control
- Remote Control (remote monitoring, mailing, etc.)
- Sediment filter (tank A)
- Speed load cart (reduces downtime for loading by more than 75%)
- Status light fivefold to display the current process state
- Traceability unit with PLC data scanner and retractable touch monitor and industrial PC with Intel processor
- Upper VA drawer baskets with PTFE mounted ASYNCHRO® stainless steel TopDown double rotors with PUSHFORCE® special nozzles

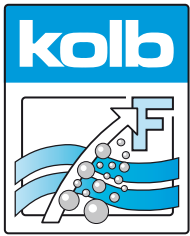

AQUBE® LH9

Fully automatic state of the art PowerSpray® XXL fine cleaning system for mass cleaning of assembled PCBs

Part number: 0905AQ9LH11 / 0905AQ9LH21 (HT version)



Internal rinse water processing (standard)

Options* for water management

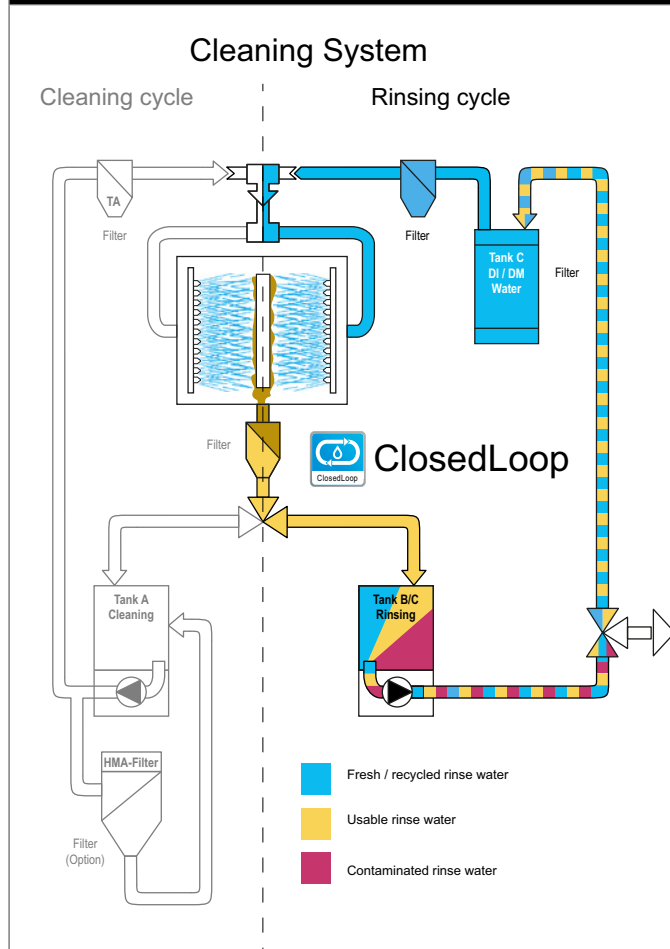

- AOSelection® unit**
separates mandatory disposable sewage water from rinse water which can be discharged into a public sewage network.
- WPSD IU SYMBIO-module**
Processes mandatory disposable sewage water to be discharged into a public sewage network.
- WPCL IUT3 SYMBIO-module**
Recycles DI / DM water for recirculation and multiple reuse in the cleaning systems clear rinsing cycle.

* Operating companies of industrial cleaning systems are responsible for proper disposal of wastewater / rinse water and (wasted) cleaning detergent. Further information on wastewater management at www.kolb-ct.com/systems/water-management/, consulting requests to info@kolb-ct.com

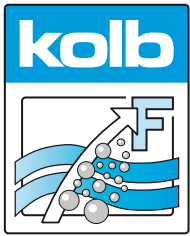

AQUBE® LH9



Fully automatic state of the art PowerSpray® XXL fine cleaning system for mass cleaning of assembled PCBs

Part number: 0905AQ9LH11 / 0905AQ9LH21 (HT version)

Technical data

Technology base	kolb PowerSpray®
Capacity	830 (19 m ²) eurocards
Process chamber dimensions	W 970 • D 955 • H 900 mm
Usable space lower basket only	W 880 • D 890 • H 760 mm
Usable space utilizing four baskets	W 880 • D 890 • H 150 mm (four times)
Volume tank A (cleaning), B / C (rinsing)	approx. 100 - 125 l each
Power supply	400 V AC, 32 A CEE / 3PH / 50 or 60 HZ
Power consumption	approx. 18 kW
Control system	PLC (EATON)
Temperature load	up to 55 °C (standard system), up to 80 °C (HT-version)
Control range drying	approx. 45 - 120 °C
Filter system	up to four stage - 1. Full flow coarse filter < 2 mm, 2. Sediment filter inside the tank, 3. 20" fine filter (1 - 100µm - process dependent), 4. HMA filter
Supply connection 1 (tap water)	3/8", hose connection 14 mm (prov. by customer: inlet water quality < 350 µS conductance value (< 10° dH) or option descaling unit)
Supply connection 2 (DI / DM water)	1/4", hose connection 14 mm (DI-net prov. by customer or bridging to tap water)
Supply connection 3 (compressed air)	6 - 8 bar (100 l / min) for HT-version or optional MediumWipe® process
Rinse water drain connection	3/4", hose connection 25 mm with integrated pump out system
Exhaust connection	Ø 160 mm, exhaust capacity 200 to 300m ³ / h
Footprint	1.700 x 1.720 mm
Operating noise	63 dB (A)
Empty weight	920 kg

Top view:
Space requirement cleaning system
(a) = Exhaust 160 mm
(b) = Status light

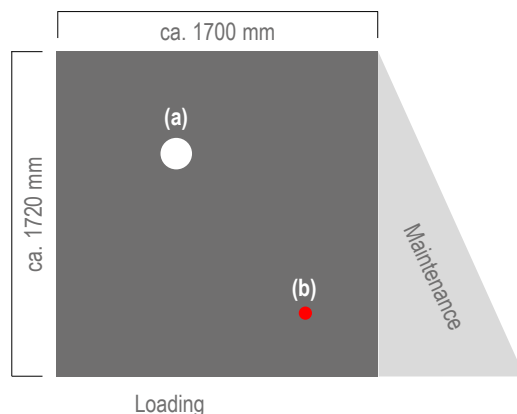

Front view:
with optional status light (b)

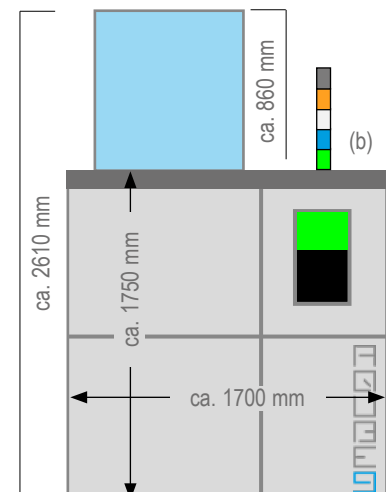



kolb CleaninGrid® Technology

AQUBE® LH9 systems are suitable for use in a kolb CleaninGrid® plant. The kolb CleaninGrid® technology is an intelligent combination and integration of cleaning, loading, water treatment and control systems to large-scale facilities for the efficient mass cleaning of assemblies, tools and machine parts. The CleaninGrid® technology is completely flexible, constructively easy to execute and based on three connection availabilities:

- Machine (A) to machine (A)
- Machine to loading / unloading automat (B)
- Machine to water processing system (C)

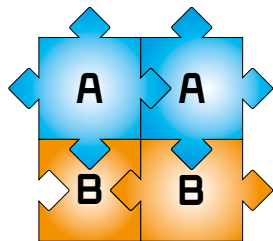
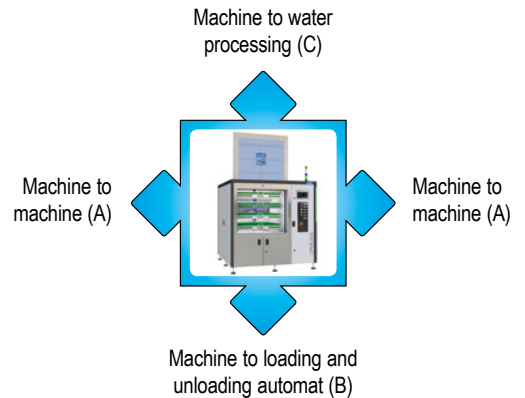

Example configuration:
Two AQUBE® LH9 systems,
two loading and unloading
units.
Capacity:
Appr. 8300 eurocards
(per 8 hour shift)
Appr. 25.000 eurocards
(per 24 hour operation)



Large installations and comprehensive washing plants

From just connecting two systems together to fulfill moderately growing volume requirements to building a complete washing center for quantities of multi-thousands of boards per day und evaporator water processing, the mutable kolb CleaninGrid® technology leaves all options.

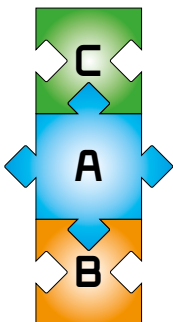

Example configuration:
AQUBE® LH9 system with
loading and unloading unit and
kolb vacuumdistiller for 100%
recycling of rinse water.
Capacity:
830 eurocards per cycle (appr.
6,5 sec. per board)



The main advantages of the kolb CleaninGrid® technology:

- * Much higher throughput than any conventional inline installation (a single AQUBE® LH9 batch system already exceeds the capacity of one average inline system).
- * Shorter cycle times per board than any PCB cleaning system on the market.
- * Extremely lower power consumption compared to any system or installation on the market with a comparable capacity.
- * Significantly lower operating costs compared to any conventional inline system with a comparable capacity.
- * The complete installation out of one hand.